



DIVAN D'EXAMEN MIXTE  
À HAUTEUR VARIABLE ÉLECTRIQUE  
VARIABLE HEIGHT COMBINED  
EXAMINATION COUCH

# Duolys<sup>®</sup>



Version : 03-2014



# Duolys®

LE DIVAN D'EXAMEN LE PLUS POLYVALENT DE SA CATÉGORIE !  
THE MOST VERSATILE COUCH OF ITS CATEGORY!

## CONFORT / COMFORT

- Dossier central électrique
  - Sellerie grande largeur 73 cm
  - Mouvements électriques doux
  - Dossier extérieur réglable par double vérin à gaz
  - Étriers intégrés (sur certains modèles)
  - Connexion de 2 commandes supplémentaires possible
- Electric central backrest
  - Large version 73 cm upholstery
  - Smooth electrical motions
  - Double gas spring assisted backrest
  - Integrated stirrups (on specific models only)
  - Possibility of 2 extra control connections



## HYGIÈNE / HYGIENE

- Système Block'n Roll exclusif (modèles 2065-30/2060-30/2064-30)
  - Sellerie d'assise amovible étanche et sans couture
  - Revêtement avec protection antibactérienne (suivant choix de couleurs, voir nuancier)
  - 2 supports rouleau de papier
  - Bac amovible en plastique sur rails
  - Toutes les parties exposées sont accessibles au nettoyage
- Exclusive Block'n Roll system (models 2065-30/2060-30/2064-30)
  - Removable seamless waterproof seatrest
  - Covering with antibacterial protection (depending on the color, see color chart)
  - 2 paper roll holders
  - Removable sliding plastic pan
  - All exposed parts are cleanable



Modèle présenté avec options/accessoires  
Products shown with options/accessories

## SÉCURITÉ / SAFETY

- Stabilité éprouvée de la table
  - Proclive - Déclive
  - Sellerie non-feu M1 (suivant choix de couleur, voir nuancier)
  - Capacité 200 kg
  - Patins de réglage sous piètement
- Tried and tested stability of the table
  - Trendelenburg and reverse Trendelenburg
    - M1 fire retardant upholstery (depending on the color, see color chart)
    - 200 kg patient weight capacity
    - Adjustable levellers under base

## ACCESSIBILITÉ ACCESSIBILITY

- Hauteur variable de 56 à 96 cm
  - Compatible avec un lève-malade
- Variable height from 56 to 96 cm
  - Compatible with a hoist



Accueil  
Welcome



Position haute  
High position



Gynécologie  
Gynecology



Proclive  
Reverse trendelenburg



Déclive  
Trendelenburg

## CARACTÉRISTIQUES STANDARD

Hauteur variable électrique de 56 à 96 cm  
 Structure acier avec finition époxy gris nuage  
 Proclive / Déclive  
 Dossier extérieur réglable par double vérin à gaz  
 Dossier central électrique  
 Sellerie largeur 73 cm avec renforts latéraux mousse ferme  
 Sellerie d'assise amovible étanche et sans couture  
 Commande manuelle  
 Patins de réglage sous piètement  
 Bac amovible en plastique sur rails (capacité 6 litres)  
 2 supports rouleau papier (longueur maxi 60 cm - ø 15 cm)  
 12 cm de dégagement au sol compatible avec le passage  
 d'un lève-malade  
 Connexion de 2 commandes supplémentaires possible  
 Poids maximum du patient autorisé 200 kg  
 (testé en dynamique à 250 kg et en statique à 800 kg)  
 Dispositif médical de classe électrique 2 / Non disponible en classe 1

## STANDARD FEATURES

Electric variable height from 56 to 96 cm  
 Steel frame structure with grey epoxy finish  
 Trendelenburg / Reverse Trendelenburg  
 Gas-spring assisted external backrest  
 Electric central backrest  
 73 cm upholstery width reinforced sides  
 Removable seamless waterproof seatrest  
 Hand control  
 Adjustable levlers under base  
 Removable sliding plastic pan (6 litre capacity)  
 2 paper roll holders (max length 60 cm - ø 15 cm)  
 Mobile hoist compatibility  
 clearance of 12 cm  
 Possibility of 2 extra control connections  
 200 kg patient weight capacity (tested at a dynamic weight  
 of 250 kg and a static weight of 800 kg)  
 Electrical medical device class 2 / Not available in class 1

Modèles Models	Patins Levellers	Block'n Roll®	Étriers intégrés Integrated stirrups	Étriers sur étaux Stirrups with clamps	Appui-jambes sur étaux Legrests with clamps
2065-10	●		●		
2065-30		●	●		
2060-10	●			●	
2060-30		●		●	
2064-10	●				●
2064-30		●			●

### Options\*

\* A demander impérativement  
 lors de la commande,  
 montage usine /  
 Plant installed, must be  
 ordered with initial order

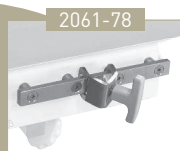

2061-78  
 Paire de rails  
 avec étaux  
 ø 16 mm & 18 mm  
 (à la place des étaux)  
 Pair of rails  
 with clamps  
 ø 16 mm & 18 mm  
 (instead of clamps)  
 (réf./ref. 2060-10  
 2060-30 / 2064-10  
 2064-30)



2061-45  
 Paire de goepfels  
 (à la place des  
 appui-jambes)  
 Pair of goepfels  
 (instead of legrests)  
 (réf./ref. 2064-10 /  
 2064-30)

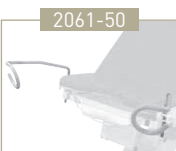

2061-50  
 Paire d'étriers avec  
 enrobage (à la place  
 des étriers simples)  
 Pair of stirrups with  
 coating (instead  
 of standard stirrups)  
 (réf./ref. 2060-10 /  
 2060-30)



2230-73  
 Trou pour visage  
 Face cutout  
 in head cushion



81036  
 4 roues à frein  
 double galet ø 50 mm  
 Set of 4 double castors  
 with brakes ø 50 mm  
 (réf./ref. 2065-10,  
 2064-10, 2060-10)



2061-30  
 Bac urologique à la  
 place du bac standard  
 Urology bowl instead  
 of standard bowl

### ACCESSOIRES SPÉCIFIQUES aux modèles 2065-10 et 2065-30 / SPECIFIC ACCESSORIES for models 2065-10 and 2065-30

### Accessoires Accessories



840  
 Paire d'appui-jambes  
 (sans housse) / Pair of  
 legrests (without cover)

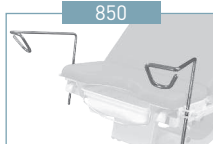

850  
 Paire d'étriers  
 Pair of stirrups



2065-78  
 Paire de rails avec étaux  
 Pair of rails with clamps  
 ø 16 mm & 18 mm



12845  
 Paire de goepfels  
 (avec housses) / Pair of  
 goepfels (with covers)

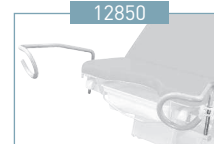

12850  
 Paire d'étriers avec  
 enrobage / Pair of stirrups  
 with coating

### ACCESSOIRES COMMUNS (tous modèles) COMMON ACCESSORIES (all models)



166  
 Paire d'étaux ø 16 mm  
 Pair of clamps ø 16 mm



856  
 Paire de poignées  
 Pair of handgrips



861  
 Paire de housses  
 pour appui-jambes  
 Pair of legrests covers



2536  
 Appui-bras (unitaire)  
 Armrest (unit)



2537  
 Housse pour appui-bras  
 (unitaire)  
 Armrest cover (unit)



2061-20  
 Bac plastique avec tuyau d'écoulement  
 (en + du bac standard)  
 Plastic pan with evacuation system  
 (in addition to the standard bowl)



Lampes/Lamps + 166  
 Se référer  
 à la documentation  
 Refer to the literature



12677-01  
 Grille anti-éclaboussures  
 Splash guard cover



1102-10  
 Appui-tête  
 Headrest



2985-01  
 Tige porte-sérum  
 autobloquant 2 crochets  
 Auto-locking 2 hook IV pole



25351  
 Paire d'étaux vissés ø 16 & 18 mm  
 (incompatible avec réf. 2061-78)  
 Pair of screwed clamps ø 16 & 18 mm  
 (not compatible with ref. 2061-78)



878-12  
 Étau coulissant pour rail  
 25x10 mm, ø 16/18 mm  
 Sliding clamp for  
 25x10 mm rail, ø 16/18 mm

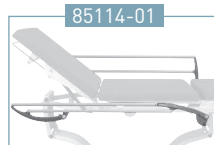









85114-01  
 Paire de barrières  
 Pair of barriers







2051-33  
 Commande par pédale  
 Foot control

**Choix de selleries non-feu M1  
Antibactérien**  
Choice of M1 fire retardant  
and antibacterial upholstery







**Classic**

-  32 - BLEU / BLUE
-  93 - COTTAGE / COTTAGE
-  35 - ROUGE / RED
-  34 - JAUNE / YELLOW
-  91 - BLANC / WHITE
-  92 - MARINE / MARINE
-  56 - OBSCURE / DARKNESS
-  57 - ANTISTATIQUE / ANTISTATIC  
Non classé M1 / Not classified M1



**Vitamin**

-  64 - RAISIN / GRAPE
-  67 - LAGON / LAGOON
-  66 - BONBON / SWEET
-  63 - CEDRAT / CEDRAT

**Cosy**

-  80 - CIEL / SKY
-  81 - VERT D'EAU / SEA GREEN
-  65 - LILAS / LILAC
-  96 - ETAIN / TIN
-  82 - GRIS SOURIS / MOUSE GREY
-  83 - NATUREL / NATURAL
-  84 - CHOCOLAT / CHOCOLATE

**Selleries RITTER**  
RITTER upholstery  
Non classé M1  
Not classified M1

-  C1 - NAVY
-  C2 - DUSTY BLUE
-  C3 - MOSS

ANTIBACTÉRIEN / NON FEU M1 - ANTIBACTERIAL / M1 FIRE RETARDANT



Poids net  
Net weight  
133 kg

Poids brut  
Gross weight  
177 kg

Volume  
1,472 m<sup>3</sup>

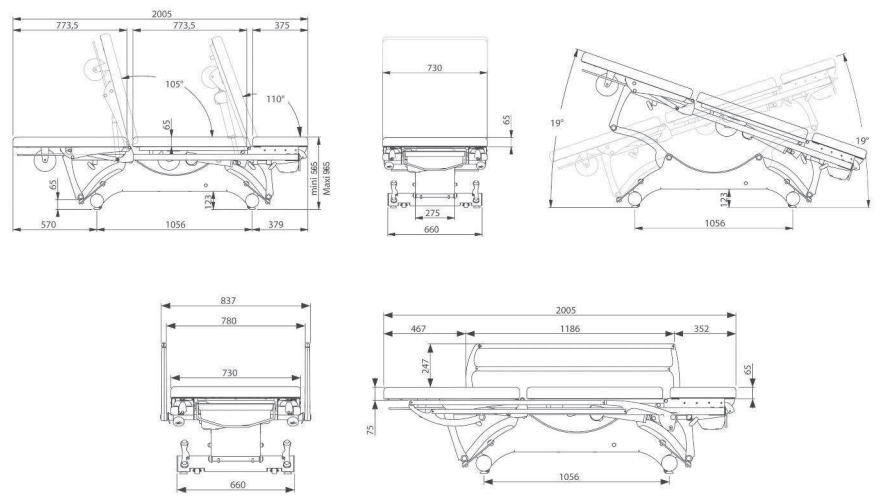

FE-12/14

