



FAUTEUIL O.R.L.
E.N.T. CHAIR



Version : 12-2013



FAUTEUIL O.R.L. E.N.T. CHAIR

CONFORT / COMFORT

- Dossier inclinable par vérin à gaz
- Mouvement du dossier et du repose jambe combiné
- Sellerie anatomique
- Rotation 360° continue avec blocage par pédale
- Appui tête réglable en hauteur et en inclinaison
- Blocage manuel de l'appui tête
- Sellerie épaisseur 50 mm
- Un seule pompe hydraulique pour contrôler tous les mouvements : hauteur, rotation, freinage
- Gas spring assisted backrest
- Combined backrest and legrest movement
 - Formed upholstery
 - 360° rotation with pedal blocking system
 - Height and angle adjustment of headrest
 - Manual blocking mechanism of headrest
 - 50mm thick upholstery
 - One single hydraulic pump controls all the chairs movements : height adjustments, brake and rotation.

ACCESSIBILITÉ ACCESSIBILITY

- Repose bras relevables
- Hauteur variable 58 à 78 cm
- Repose jambe escamotable sous le coussin d'assise
- Swing back armrests
- Variable height from 58 cm to 78 cm
- Retractable footrest

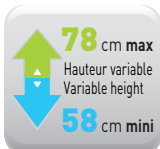

Référence du modèle
Model reference
2863

Modèle présenté avec options/accessoires
Product shown with options/accessories

SÉCURITÉ / SAFETY

- Capacité 170 kg
- Sellerie non feu M1
- Socle circulaire très stable avec antidérapant périphérique
- Colonne hydraulique largement dimensionnée (4 cm) pour une grande longévité
- 170kg patient weight capacity
- M1 fire retardant and antibacterial covering
 - Very stable circular base with a non-slip surface around
 - Hydraulic cylinder largely dimensioned (4cm) ensures a long life span of the chair

HYGIÈNE / HYGIENE

- Possibilité d'adapter des housses pour appui bras
- Structure facile à nettoyer
- Revêtement avec protection antibactérienne
- Covers available for armrests
- Easy to clean
- Covering with antibacterial protection

CARACTÉRISTIQUES STANDARD

Hauteur variable hydraulique de 58 cm à 78 cm
 Mouvement du dossier et de repose-jambes combiné (commande bilatérale)
 Rotation 360° avec blocage par pédale
 Appui-tête réglable en hauteur et en inclinaison avec blocage manuel
 Repose-bras relevables
 Sellerie épaisseur 5 cm avec revêtement non-feu M1 et protection antibactérienne
 Socle corolle chromé

STANDARD FEATURES

Hydraulic height adjustment from 58 cm to 78 cm
 Combined backrest and legrest movement (bilateral control)
 360° rotation with pedal blocking system
 Height and angle adjustment of headrest with manual blocking mechanism
 Swing back armrests
 5 cm thick upholstery with M1 fire retardant and antibacterial covering
 Chrome plated base



Le diamètre (4 cm) de la colonne hydraulique (tige de vérin) a été largement dimensionné pour garantir une extrême longévité du fauteuil.

The diameter (4 cm) of the hydraulic cylinder, largely dimensioned, ensures a long life span of the chair.



Un accès aisé au fauteuil grâce aux repose-bras relevables et au repose-jambe qui pivote sous le coussin d'assise. La sellerie anatomique offre un confort maximal pour votre patient pendant l'examen.

Easy access to the chair is ensured with adjustable armrests and a retractable footrest. The upholstery moves together allowing for maximum patient comfort throughout the examination.



Simplicité d'utilisation : une seule pompe hydraulique contrôle les mouvements du fauteuil : réglage de la hauteur, frein et rotation. L'appui-tête se règle en hauteur et en inclinaison.

Easy to use: one single hydraulic pump controls all the chair movements: height adjustment, brake and rotation. The height and inclination of the head-rest can be adjusted.

Option



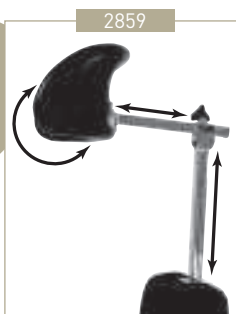





* A demander impérativement lors de la commande, montage usine / Plant installed, must be ordered with initial order







Appui-tête polyuréthane
 Polyurethane headrest

**Choix de selleries non-feu M1
Antibactérien**
Choice of M1 fire retardant
and antibacterial upholstery





Classic

-  32 - BLEU / BLUE
-  93 - COTTAGE / COTTAGE
-  35 - ROUGE / RED
-  34 - JAUNE / YELLOW
-  91 - BLANC / WHITE
-  92 - MARINE / MARINE
-  56 - OBSCURE / DARKNESS
-  57 - ANTISTATIQUE / ANTISTATIC
Non classé M1 / Not classified M1

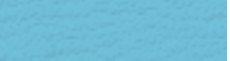
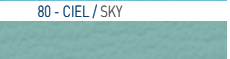

Vitamin

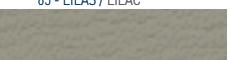
-  64 - RAISIN / GRAPE
-  67 - LAGON / LAGOON
-  66 - BONBON / SWEET
-  63 - CEDRAT / CEDRAT

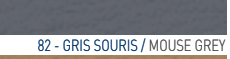
Cosy

-  80 - CIEL / SKY
-  81 - VERT D'EAU / SEA GREEN
-  65 - LILAS / LILAC
-  96 - ETAIN / TIN
-  82 - GRIS SOURIS / MOUSE GREY
-  83 - NATUREL / NATURAL
-  84 - CHOCOLAT / CHOCOLATE

Selleries RITTER
RITTER upholstery
Non classé M1
Not classified M1

-  C1 - NAVY
-  C2 - DUSTY BLUE
-  C3 - MOSS

ANTIBACTÉRIEN / NON FEU M1 - ANTIBACTERIAL / M1 FIRE RETARDANT



Poids net
Net weight
65 kg

Poids brut
Gross weight
79 kg

Volume
0,92 m³

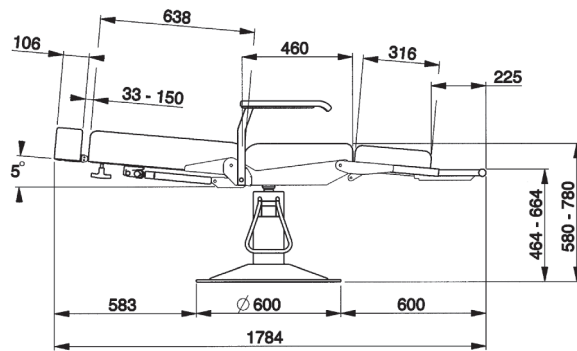
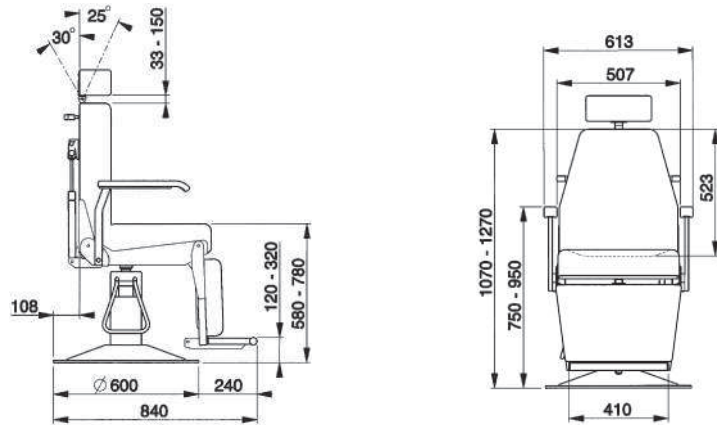

FE-49/13

