

Fiche de mesure / Tarif public

X850 Corpus 3G

Prix valables à partir de: 1/jan/24



X850 Corpus 3G

Coût de livraison : 55 € HT

Information client	
Client (Nom / No.)	/
Contact	
Adresse	
CP / Ville	/
Tél / Fax	/
Information utilisateur	
Nom	/
Adresse	
CP / Ville	/
Tél.	
E-mail	

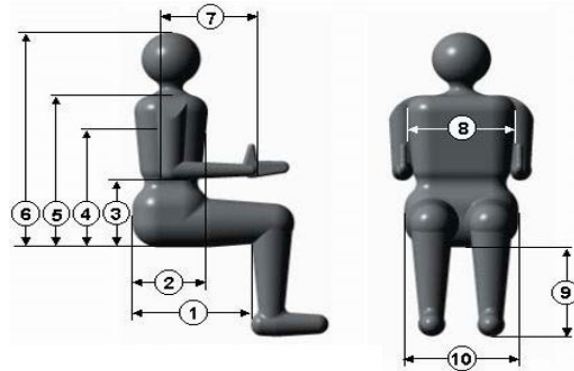

Mesures anthropométriques

Diagnostic		Poids:	kg	3:	cm	7:	cm
		Taille:	cm	4:	cm	8:	cm
		1:	cm	5:	cm	9:	cm
		2:	cm	6:	cm	10:	cm

						<input checked="" type="checkbox"/> Choix obligatoire <input type="checkbox"/> / <input type="radio"/> Choix optionnel <input type="checkbox"/> / <input checked="" type="radio"/> Choix par défaut		
Numéro d'article	Position Gauche Droite	Tarif Public (€) HT	Tarif Public (€) TTC	Tarif LPPR Code LPPR	Information additionnelle			

Châssis							
X850 CORPUS 3G	106681-99-0	<input checked="" type="checkbox"/>	15965,00	16843,08			
Coloris							
CAPOT X850 DARK BLUE METALLIC	103174-99-0	<input type="radio"/>	0,00	0,00			
CAPOT X850 DARK GREY METALLIC	103175-99-0	<input type="radio"/>	0,00	0,00			
CAPOT X850 RED METALLIC	103173-99-0	<input type="radio"/>	0,00	0,00			
Roues folles							
ALLONGEMENT ÉLECTRIQUE DU CHÂSSIS (815-1015MM)	103012-99-0	<input checked="" type="radio"/>	1339,00	1412,65			
EMPATTEMENT FIXE (815-1015MM)	103011-99-0	<input type="radio"/>	0,00	0,00			
Batteries							
BATTERIES, GEL, 97 Ah (2 PCS)	101999-99-0	<input checked="" type="radio"/>	0,00	0,00			
Chargeur							
CHARGEUR VOLTPRO 24/10 MK GEL EU	109163-99-0	<input checked="" type="radio"/>	0,00	0,00			

Accessoires Châssis															
RÉTROVISEUR DROITE	103101-99-0	<input type="checkbox"/>	138,00	145,59											
RÉTROVISEUR GAUCHE	103137-99-0	<input type="checkbox"/>	138,00	145,59											
PANIER À BAGAGES X850	103019-99-0	<input type="radio"/>	375,00	395,63											
SAC PORTE BAGAGE X850 AVEC ÉCLAIRAGE	108004-99-0	<input type="radio"/>	762,00	803,91											
PORTE-CANNES MONTÉ À DROITE	100292-99-0	<input type="checkbox"/>	134,00	141,37											
PORTE-CANNES MONTÉ À GAUCHE	100293-99-0	<input type="checkbox"/>	134,00	141,37											
ARRÊT À DISTANCE (2CH)	106278-99-0	<input type="checkbox"/>	600,00	633,00											
BÂCHE POUR TOUS MODÈLES (NYLON)	101888-99-0	<input type="radio"/>	122,00	128,71											
BÂCHE POUR X850 AVEC ARCEAU	101899-99-0	<input type="radio"/>	255,00	269,03											
INSERTS PALETTES	101892-99-0	<input type="checkbox"/>	172,00	181,46											
LOCK DE FIXATIONS POUR TRANSPORT	104875-99-0	<input type="checkbox"/>	0,00	0,00											
GOUPILLE DE VERROUILLAGE POUR LOCK DE FIXATIONS	104876-99-0	<input type="checkbox"/>	0,00	0,00											
Montage d'assise															
HAUTEUR D'ASSISE FIXE	103033-99-0	<input checked="" type="radio"/>	0,00	0,00											
ÉLÉVATEUR ÉLECTR D'ASSISE	103022-99-0	<input type="radio"/>	1982,00	2091,01											
INCLINAISON D'ASSISE FIXE	106782-99-0	<input checked="" type="radio"/>	0,00	0,00											
INCLINAISON D'ASSISE ÉLECTRIQUE	106918-99-0	<input type="radio"/>	1896,00	2000,28											
Assise															
CORPUS 3G / X850	107243-99-0	<input checked="" type="checkbox"/>	0,00	0,00											
Dimensions du siège															
		Profondeur													
	Dim. (mm)	370	395	420	445	470	495	520	545	570					
Largeur	420	<input type="radio"/>	<input type="radio"/>	<input type="radio"/>	<input type="radio"/>	<input type="radio"/>	<input type="radio"/>	<input type="radio"/>	<input type="radio"/>	<input type="radio"/>					
	470	<input type="radio"/>	<input type="radio"/>	<input checked="" type="radio"/>	<input type="radio"/>	<input type="radio"/>	<input type="radio"/>	<input type="radio"/>	<input type="radio"/>	<input type="radio"/>					
	520	<input type="radio"/>	<input type="radio"/>	<input type="radio"/>	<input type="radio"/>	<input type="radio"/>	<input type="radio"/>	<input type="radio"/>	<input type="radio"/>	<input type="radio"/>					
	570	<input type="radio"/>	<input type="radio"/>	<input type="radio"/>	<input type="radio"/>	<input type="radio"/>	<input type="radio"/>	<input type="radio"/>	<input type="radio"/>	<input type="radio"/>					
Coussin d'assise															
COUSSIN D'ASSISE CORPUS ERGO VINYLE	10XXXX-99-0	<input checked="" type="radio"/>	0,00	0,00											
COUSSIN D'ASSISE CORPUS ERGO STRETCH AIR	10XXXX-99-0	<input type="radio"/>	0,00	0,00											
COUSSIN D'ASSISE VINYLE	10XXXX-99-0	<input type="radio"/>	0,00	0,00											
SANS COUSSIN D'ASSISE	105118-99-0	<input type="radio"/>	-145,00	-152,98											
CALES D'ASSISE "ERGO"	105219-99-0	<input checked="" type="checkbox"/>	0,00	0,00											
Autres Coussins d'assise															
PROTECTION D'INCONTINENCE		0	<input type="checkbox"/>	157,00	165,64										
COUSSIN D'ASSISE ERGO AIR		<input type="checkbox"/>	544,00	573,92											
ROHO QUADRO SELECT (Tarifs à partir de)		<input type="checkbox"/>													
ROHO CONTOUR (Tarifs à partir de)		<input type="checkbox"/>													
ROHO HYBRID ELITE (Tarifs à partir de)		<input type="checkbox"/>													
Inclinaison du dossier															
DOSSIER INCL MANUELLEMENT 90-120°	102221-99-0	<input checked="" type="radio"/>	0,00	0,00											
DOSSIER INCLINABLE ÉLECTRIQUE 90-120°	103180-99-0	<input type="radio"/>	1339,00	1412,65											
DOSSIER FIXE	105066-99-0	<input checked="" type="radio"/>	0,00	0,00											
DOSSIER BIOMECHANIQUE	105067-99-0	<input type="radio"/>	643,00	678,37											
Type de Dossier / Support Dossier															
COURT	107262-99-0	<input type="radio"/>	0,00	0,00											
STANDARD	107264-99-0	<input checked="" type="radio"/>	0,00	0,00											
ADAPT. DOSSIER DIRECT	107261-99-0	<input type="radio"/>	536,00	565,48											
ADAPT. DOSSIER TUBUL.	107265-99-0	<input type="radio"/>	572,00	603,46											
SANS DOSSIER	107272-99-0	<input type="radio"/>	-184,00	-194,12											

Dimensions de dossier Permobil								
		Court	Hauteurs standard					
Dim. (mm)		470	545	570	595	620	645	670
Largeur	360	<input type="radio"/>	<input type="radio"/>	<input type="radio"/>	<input type="radio"/>	<input type="radio"/>	<input type="radio"/>	<input type="radio"/>
	410	<input type="radio"/>	<input type="radio"/>	<input checked="" type="radio"/>	<input type="radio"/>	<input type="radio"/>	<input type="radio"/>	<input type="radio"/>
	460	<input type="radio"/>	<input type="radio"/>	<input type="radio"/>	<input type="radio"/>	<input type="radio"/>	<input type="radio"/>	<input type="radio"/>
	510	<input type="radio"/>	<input type="radio"/>	<input type="radio"/>	<input type="radio"/>	<input type="radio"/>	<input type="radio"/>	<input type="radio"/>

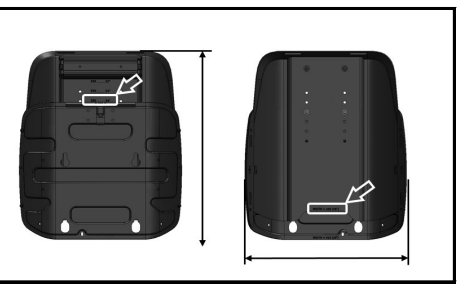

Coussin de dossier					
COUSSIN DE DOSSIER VINYLE	10XXXX-99-0	<input checked="" type="radio"/>	0,00	0,00	
COUSSIN DE DOSSIER STRETCH AIR	10XXXX-99-0	<input type="radio"/>	0,00	0,00	
SANS COUSSIN DE DOSSIER	105117-99-0	<input type="radio"/>	-183,00	-193,07	
SUPPORTS DE DOSSIER "ERGO" SMALL/5CM(PAIRE)	105569-99-0	<input checked="" type="radio"/>	0,00	0,00	
SUPPORTS DE DOSSIER "ERGO" LARGE/7CM(PAIRE)	105570-99-0	<input type="radio"/>	0,00	0,00	



Dossier Agility Max Contour											
		(H) Hauteur			(MH)	Hauteur de montage					
(W)	Dim. ("/mm)	16"	18"	20"		16"	18"	20"			
Largeur	14"/355mm	<input type="radio"/>	<input type="radio"/>	<input type="radio"/>		470mm	<input type="radio"/>			955,00	1007,53
	15"/380mm	<input type="radio"/>	<input type="radio"/>	<input type="radio"/>		495mm	<input type="radio"/>				
	16"/405mm	<input type="radio"/>	<input type="radio"/>	<input type="radio"/>		520mm	<input type="radio"/>	<input type="radio"/>			
	17"/430mm	<input type="radio"/>	<input type="radio"/>	<input type="radio"/>		545mm	<input type="radio"/>	<input type="radio"/>	<input type="radio"/>		
	18"/455mm	<input type="radio"/>	<input type="radio"/>	<input type="radio"/>		570mm	<input type="radio"/>	<input type="radio"/>	<input type="radio"/>		
	19"/485mm	<input type="radio"/>	<input type="radio"/>	<input type="radio"/>		595mm	<input type="radio"/>	<input type="radio"/>	<input type="radio"/>		
	20"/510mm	<input type="radio"/>	<input type="radio"/>	<input type="radio"/>		620mm		<input type="radio"/>	<input type="radio"/>		
OPTION NON NÉCESSAIRE			<input checked="" type="radio"/>			645mm			<input type="radio"/>		



Hauteur support lateral Agility					
DOSSIER AGILITY MONTÉ BAS (STANDARD)	108538-99-0	<input checked="" type="radio"/>	0,00	0,00	
DOSSIER AGILITY MONTÉ HAUTE	108537-99-0	<input type="radio"/>	0,00	0,00	



Montage d'accoudoirs					
DISTANCE ENTRE ACCOUDOIRS : ÉTROIT (38-48CM)	107251-99-0	<input checked="" type="radio"/>	0,00	0,00	
DISTANCE ENTRE ACCOUDOIRS : LARGE (48-58CM)	107252-99-0	<input type="radio"/>	0,00	0,00	
DISTANCE ENTRE ACCOUDOIRS 380MM	105083-99-0	<input type="radio"/>	0,00	0,00	
DISTANCE ENTRE ACCOUDOIRS 430MM	105084-99-0	<input checked="" type="radio"/>	0,00	0,00	
DISTANCE ENTRE ACCOUDOIRS 480MM	105085-99-0	<input type="radio"/>	0,00	0,00	
DISTANCE ENTRE ACCOUDOIRS 530MM	105086-99-0	<input type="radio"/>	0,00	0,00	
DISTANCE ENTRE ACCOUDOIRS 580MM	105082-99-0	<input type="radio"/>	0,00	0,00	
HAUTEUR D'ACCOUDOIRS POS 1: 230MM	106631-99-0	<input type="radio"/>	0,00	0,00	
HAUTEUR D'ACCOUDOIRS POS 2: 255MM	106632-99-0	<input type="radio"/>	0,00	0,00	
HAUTEUR D'ACCOUDOIRS POS 3: 280MM	106633-99-0	<input checked="" type="radio"/>	0,00	0,00	
HAUTEUR D'ACCOUDOIRS POS 4: 305MM	106634-99-0	<input type="radio"/>	0,00	0,00	
HAUTEUR D'ACCOUDOIRS POS 5: 330MM	106635-99-0	<input type="radio"/>	0,00	0,00	
ACCOUDOIRS FIXES	105070-99-0	<input checked="" type="radio"/>	0,00	0,00	
ACCOUDOIRS PIVOTANTS	105072-99-0	<input type="radio"/>	207,00	218,39	



Accoudoirs												
	Gauche				Droit							
	260	335	410	460	260	335	410	460				
SANS ACCOUDOIR	<input type="radio"/>	<input type="radio"/>	<input type="radio"/>	<input type="radio"/>	<input type="radio"/>	<input type="radio"/>	<input type="radio"/>	<input type="radio"/>	-58,00	-61,19		
ACCOUDOIR TEXTILE	<input type="radio"/>	<input type="radio"/>	<input type="radio"/>	<input type="radio"/>	<input type="radio"/>	<input type="radio"/>	<input type="radio"/>	<input type="radio"/>	0,00	0,00		
ACCOUDOIR VINYLE	<input type="radio"/>	<input checked="" type="radio"/>	<input type="radio"/>	<input type="radio"/>	<input type="radio"/>	<input checked="" type="radio"/>	<input type="radio"/>	<input type="radio"/>	0,00	0,00		
ACCOUDOIR GEL	<input type="radio"/>	<input type="radio"/>	<input type="radio"/>	<input type="radio"/>	<input type="radio"/>	<input type="radio"/>	<input type="radio"/>	<input type="radio"/>	112,00	118,16		
ACCOUDOIR MOULÉ GAUCHE					108860-99-0	<input type="checkbox"/>				241,00	254,26	
ACCOUDOIR MOULÉ DROITE					108861-99-0		<input type="checkbox"/>				241,00	254,26
TAPIS À MAIN MOULÉ MOYEN GAUCHE					108862-99-0	<input type="radio"/>				75,00	79,13	
TAPIS À MAIN MOULÉ GRAND GAUCHE					108864-99-0	<input type="radio"/>				75,00	79,13	
TAPIS À MAIN MOULÉ MOYEN DROITE					108863-99-0		<input type="radio"/>				75,00	79,13
TAPIS À MAIN MOULÉ GRAND DROITE					108865-99-0		<input type="radio"/>				75,00	79,13
Repose-jambes												
REP.JAMBES, COMPENSATION 185MM					107366-99-0	<input type="checkbox"/>				771,00	813,41	
Palettes												
PALETTES 2X16CM LONG. JAMBE 29-50CM AL.					105436-99-0	<input type="checkbox"/>				0,00	0,00	
Accessoires Siège												
Appui-tête												
HAUTEUR DE DOSSIER					COURT	<input type="radio"/>	<input type="radio"/>	STANDARD		<input type="radio"/>		
Appui-tête BodiLink												
TAILLE APPUI-TETE BodiLink	S 180x110	<input type="radio"/>	M 250x125	<input type="radio"/>	L 340x130	<input type="radio"/>						
Appui latéral / contacteur gauche pour appui-tête												
APPUIE LATERAL GAUCHE ESC. STD POSITION HAUTE					107860-99-0	<input type="radio"/>				408,00	430,44	
APPUIE LATERAL GAUCHE ESC. LONG POSITION HAUTE					107861-99-0	<input checked="" type="radio"/>				408,00	430,44	
Appui latéral / contacteur droit pour appui-tête												
APPUIE LATERAL DROIT ESC. STD POSITION HAUTE					107941-99-0	<input type="radio"/>				408,00	430,44	
APPUIE LATERAL DROIT ESC. LONG POSITION HAUTE					107944-99-0	<input type="radio"/>				408,00	430,44	
Cales tronc												
BODILINK CALE TRONC G. STRETCH-AIR 75X140					109025-99-0	<input type="radio"/>	<input type="radio"/>			392,00	413,56	
BODILINK CALE TRONC G. STRETCH-AIR 100X165					109027-99-0	<input type="radio"/>	<input type="radio"/>			392,00	413,56	









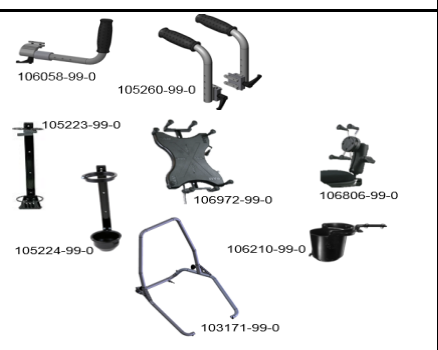
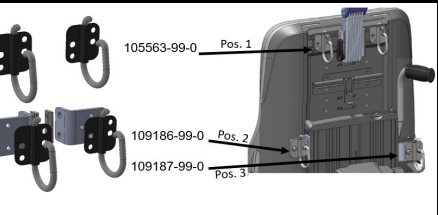
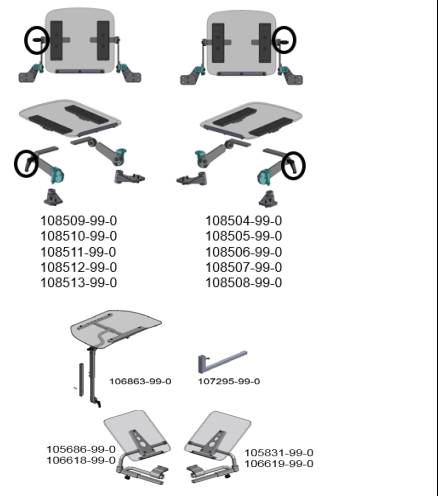
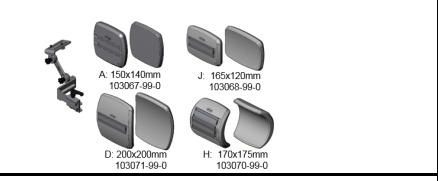
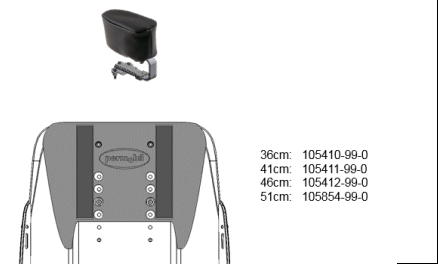







Cales cuisse						
BODILINK CALE CUISSE G. STRETCH-AIR 90X110 S(B)	109179-99-0	○		○	236,00	248,98
BODILINK CALE CUISSE G. STRETCH-AIR 200X90 L(C)	109181-99-0	○		○	257,00	271,14
BODILINK CALE CUISSE G. STRETCH-AIR 300x90 XL(G)	109036-99-0	○		○	278,00	293,29
Cales bassin						
BODILINK CALE BASSIN G. STRETCH-AIR 90X110 S(B)	109032-99-0	○		○	236,00	248,98
BODILINK CALE BASSIN G. STRETCH-AIR 200X90 L(C)	109034-99-0	○		○	257,00	271,14
BODILINK CALE BASSIN G. STRETCH-AIR 150X140 M(A)	109038-99-0	○		○	257,00	271,14
Supports mollets						
SUP. MOLLETS, L (A) 150x140 /MESH	105250-99-0			○	318,00	335,49
SUP. MOLLETS, S (B) 110x90 /MESH	105252-99-0			○	242,00	255,31
Cales-coude et rebords accoudoirs						
CALE-COUDE GAUCHE	107838-99-0	□			288,00	303,84
CALE-COUDE DROITE	107839-99-0			□	288,00	303,84
REBORD D'ACCOUDOIR EXTERNE, GAUCHE	107863-99-0	□			105,00	110,78
REBORD D'ACCOUDOIR EXTERNE, DROITE	107840-99-0			□	105,00	110,78
REBORD D'ACCOUDOIR INTERNE, GAUCHE	107865-99-0	□			105,00	110,78
REBORD D'ACCOUDOIR INTERNE DROITE	107864-99-0			□	105,00	110,78
Ceintures						
CEINTURE, BODYPOINT 2-P MEDIUM, SANS COUSSINET	104518-99-0			○	67,00	70,69
CEINTURE, BODYPOINT 2-P LARGE, SANS COUSSINET	104514-99-0			○	77,00	81,24
CEINTURE, BODYPOINT 2-P MEDIUM, AVEC COUSSINET	104520-99-0			○	103,00	108,67
CEINTURE, BODYPOINT 2-P LARGE, AVEC COUSSINET	104516-99-0			○	108,00	113,94
CEINTURE, BODYPOINT 2-P X-LARGE, AVEC COUSSINET	106531-99-0			○	108,00	113,94
BP CEINT. CALE BASSIN 2PT C PULL LATCH 46CM PAD	108267-99-0			○	103,00	108,67
BP CEINT. CALE BASSIN 2PT C PULL LATCH 62CM PAD	108266-99-0			○	106,00	111,83
BP CEINT. CALE BASSIN 4PT R PULL PUSH 46CM PAD	108265-99-0			○	111,00	117,11
CEINTURE A FERMETURE RAPIDE	100518-99-0			○	0,00	0,00
CEINTURE A ENROULEUR	100519-99-0	○		○	140,00	147,70
CEINTURE A ENROULEUR LONGUE (+200MM)	100600-99-0	○		○	155,00	163,53
CEINTURE HARNAIS 4-POINTS	100529-99-0			○	183,00	193,07
CEINTURE, BODYPOINT MONOFLEX MEDIUM	105840-99-0			○	108,00	113,94
CEINTURE, BODYPOINT MONOFLEX LARGE	105839-99-0			○	108,00	113,94
CEINTURE, BODYPOINT MONOFLEX X-LARGE	105850-99-0			○	112,00	118,16
BP HARNAIS PIVOTFIT S SHOULDER SUPPORT FP	108275-99-0			○	161,00	169,86
BP HARNAIS PIVOTFIT M SHOULDER SUPPORT FP	108276-99-0			○	161,00	169,86
BP HARNAIS PIVOTFIT L SHOULDER SUPPORT FP	108277-99-0			○	166,00	175,13
BP HARNAIS PIVOTFIT XL SHOULDER SUPPORT FP	108278-99-0			○	166,00	175,13
BP HARNAIS STAYFLEX XS CHEST SUPPORT FP	108269-99-0			○	174,00	183,57
BP HARNAIS STAYFLEX S CHEST SUPPORT FP	108270-99-0			○	174,00	183,57
BP HARNAIS STAYFLEX M CHEST SUPPORT FP	108271-99-0			○	179,00	188,85
BP HARNAIS STAYFLEX L CHEST SUPPORT FP	108272-99-0			○	179,00	188,85
BP HARNAIS STAYFLEX XL CHEST SUPPORT FP	108273-99-0			○	186,00	196,23
CEINT. VENTRALE BODYPOINT ÉLASTIQUE LARGE	105843-99-0			○	97,00	102,34
CEINT. VENTRALE BODYPOINT ÉLASTIQUE SMALL	105845-99-0			○	92,00	97,06
SANGLE DE MAINTIEN PIEDS AVEC COUSSINET (JEU DE 2)	103104-99-0			○	75,00	79,13
SANGLE DE MAINTIEN PIEDS SANS COUSSINET (JEU DE 2)	103427-99-0			○	34,00	
BP FIXATION DES CHEVILLES MEDIUM	108242-99-0			○	152,00	
BP FIXATION DES CHEVILLES LARGE	108243-99-0			○	152,00	160,36



Plot d'abduction					
PLOT D'ABDUCTION	106762-99-0	<input type="checkbox"/>	0,00	0,00	
Appui épaule					
APPUI ÉPAULE SUR DOSSIER 36CM	105410-99-0	<input type="radio"/>	104,00	109,72	
APPUI ÉPAULE SUR DOSSIER 41CM	105411-99-0	<input type="radio"/>	104,00	109,72	
APPUI ÉPAULE SUR DOSSIER 46CM	105412-99-0	<input type="radio"/>	104,00	109,72	
APPUI ÉPAULE SUR DOSSIER 51CM	105854-99-0	<input type="radio"/>	104,00	109,72	
Supports amputation					
SUPPORT DE MOIGNON SMALL (A)150x140 TEXTILE	106497-99-0	<input type="radio"/>	<input type="checkbox"/>	<input type="radio"/>	325,00 342,88
SUPPORT DE MOIGNON MEDIUM (J)165x120 TEXTILE	106500-99-0	<input type="radio"/>	<input type="checkbox"/>	<input type="radio"/>	325,00 342,88
SUPPORT DE MOIGNON LARGE (H)170x175 TEXTILE	106499-99-0	<input type="radio"/>	<input type="checkbox"/>	<input type="radio"/>	380,00 400,90
SUPPORT DE MOIGNON XLARGE (D)200x200 TEXTILE	106498-99-0	<input type="radio"/>	<input type="checkbox"/>	<input type="radio"/>	380,00 400,90
Appui lombaire					
APPUI LOMBAIRE GONFLABLE	101972-99-0	<input type="checkbox"/>	171,00	180,41	
Tablettes					
TABLETTE AMOV.INCLINABLE GAUCHE,LARGEUR 330MM	108510-99-0	<input type="radio"/>	502,00	529,61	
TABLETTE AMOV.INCLINABLE DROITE,LARGEUR 330MM	108505-99-0	<input type="radio"/>	502,00	529,61	
TABLETTE AMOV.INCLINABLE GAUCHE,LARGEUR 380MM	108511-99-0	<input type="radio"/>	502,00	529,61	
TABLETTE AMOV.INCLINABLE DROITE,LARGEUR 380MM	108506-99-0	<input type="radio"/>	502,00	529,61	
TABLETTE AMOV.INCLINABLE GAUCHE,LARGEUR 430MM	108512-99-0	<input type="radio"/>	502,00	529,61	
TABLETTE AMOV.INCLINABLE DROITE,LARGEUR 430MM	108507-99-0	<input type="radio"/>	502,00	529,61	
TABLETTE AMOV.INCLINABLE GAUCHE,LARGEUR 480MM	108513-99-0	<input type="radio"/>	502,00	529,61	
TABLETTE AMOV.INCLINABLE DROITE,LARGEUR 480MM	108508-99-0	<input type="radio"/>	502,00	529,61	
TABLETTE AMOV.INCLINABLE FIXATION GAUCHE OU DROIT	106863-99-0	<input type="radio"/>	491,00	518,01	
SUPPORT POSITION SUPPL. DE TABLETTE	107295-99-0	<input type="checkbox"/>	0,00	0,00	
TABLETTE BLOC NOTE MONTÉE SOUS ACCOUDOIR GAUCHE	105686-99-0	<input type="radio"/>	263,00	277,47	
TABLETTE BLOC NOTE MONTÉE SOUS ACCOUDOIR DROITE	105831-99-0	<input type="radio"/>	263,00	277,47	
Pochettes					
POCHETTE ACCOUDOIR DROIT NOIRE	107339-99-0	<input type="checkbox"/>	0,00	0,00	
POCHETTE ACCOUDOIR GAUCHE NOIRE	107338-99-0	<input type="checkbox"/>	0,00	0,00	
POCHETTE CENTRALE NOIRE	107340-99-0	<input type="checkbox"/>	38,00	40,09	
SAC "BACKPACK"	102059-99-0	<input type="checkbox"/>	188,00	198,34	
CROCHETS DE FIXATION POUR SAC UNITRACK	105563-99-0	<input type="radio"/>	36,00	37,98	
CROCHET DE FIXATION POUR SAC HAUTE	109186-99-0	<input type="radio"/>	36,00	37,98	
CROCHET DE FIXATION POUR SAC BAS	109187-99-0	<input type="radio"/>	36,00	37,98	
OPTION NON NÉCESSAIRE		<input checked="" type="radio"/>			
POS.CROCHET DE FIX. P. SAC GAUCHE UNIQUEMENT	109189-99-0	<input type="radio"/>	0,00	0,00	
POS.CROCHET DE FIX. P. SAC DROITE UNIQUEMENT	109188-99-0	<input type="radio"/>	0,00	0,00	
Accessoires					
SUPPORT DE POIGNÉE SOUS ACCOUDOIR	106058-99-0	<input type="radio"/>	144,00	151,92	
POIGNÉES DE TRANSFERT (LA PAIRE)	105260-99-0	<input type="checkbox"/>	161,00	169,86	
PORTE-CANNES	105223-99-0	<input type="radio"/>	137,00	144,54	
SUPPORT BOUTEILLE OXYGÈNE C3G	105224-99-0	<input type="checkbox"/>	249,00	262,70	
SUPPORT GOBELET	106210-99-0	<input type="checkbox"/>	35,00	36,93	
SUPPORT TÉLÉPHONE X-GRIP	106806-99-0	<input type="checkbox"/>	94,00	99,17	
SUPPORT TABLETTE X-GRIP	106972-99-0	<input type="checkbox"/>	158,00	166,69	
ARCEAU BAS	103171-99-0	<input type="checkbox"/>	724,00	763,82	



Commandes					
Manipulateur					
MANIPULATEUR AVEC PETIT JOYSTICK	103024-99-0	<input checked="" type="radio"/>	0,00	0,00	 103024-99-0
MANIPULATEUR AVEC GRAND JOYSTICK	103025-99-0	<input type="radio"/>	1264,00	1333,52	
Support de joystick					
SUPPORT BOÎTIER DE COMM. STD L=335MM DROITE /BAS	101612-99-0	<input checked="" type="radio"/>	0,00	0,00	 101612-99-0  107753-99-0
SUPPORT BOÎTIER DE COMM. STD L=335MM GAUCHE / BAS	102855-99-0	<input type="radio"/>	0,00	0,00	
PANTOGRAPHE GAUCHE/DROITE X850	107753-99-0	<input type="radio"/>	0,00	0,00	
Support réglable en hauteur					
SUPPORT HAUTEUR REGLABLE DROITE	107960-99-0	<input type="radio"/>	142,00	149,81	 107960-99-0  107963-99-0  108005-99-0
SUPPORT HAUTEUR REGLABLE GAUCHE	107963-99-0	<input type="radio"/>	142,00	149,81	
SUPPORT HAUTEUR REGLABLE	108005-99-0	<input type="radio"/>	142,00	149,81	
Embouts alternatifs de joystick					
JOYSTICK MODÈLE CUPULE MENTON DIA. 38	100960-99-0	<input type="radio"/>	18,00	18,99	 Chin cup  T-Grip  Big ball
JOYSTICK MODÈLE POIGNEE EN T H. 80	100961-99-0	<input type="radio"/>	50,00	52,75	
JOYSTICK MODÈLE GROSSE BOULE DIA. 38	100962-99-0	<input type="radio"/>	18,00	18,99	
JOYSTICK MODÈLE BALLE MOUSSE DIA. 70	100963-99-0	<input type="radio"/>	27,00	28,49	
JOYSTICK MODÈLE CHAMPIGNON DIA. 45	100964-99-0	<input type="radio"/>	27,00	28,49	
JOYSTICK MODÈLE TIGE H. 80	100965-99-0	<input type="radio"/>	27,00	28,49	
JOYSTICK MODÈLE BOULE DIA. 30	101165-99-0	<input type="radio"/>	18,00	18,99	
JOYSTICK MODÈLE BALLE MOUSSE NOIR (CÔNE)	105442-99-0	<input type="radio"/>	26,00	27,43	
JOYSTICK MODÈLE BODYPOINT 7.5CM U-SHAPED	105846-99-0	<input type="radio"/>	66,00	69,63	
JOYSTICK MODÈLE BODYPOINT 10CM U-SHAPED	105847-99-0	<input type="radio"/>	66,00	69,63	
JOYSTICK MODÈLE BODYPOINT RUBBER DOME	105848-99-0	<input type="radio"/>	61,00	64,36	
					 Small ball  Soft ball (cone)
					 7.5cm U-shaped  10cm U-shaped  Rubber Dome
Remarques					